



SLIDING



SOCIALIZING



CLIMBING



INFORMATION ABOUT THE PRODUCT



Dimensions	131 x 322 cm
Safety zone	431 x 672 cm
Safety zone area	22 m ²
Overall height	327 cm
Free fall height	120 cm
Amount of users	5
Product complies with EN 1176-1:2017-12	YES
Availability of spare parts	YES
Age range	3-12
According to EN 1176-1:2017-12 norm, the product requires applying a safety surface according to the product's free fall height.	

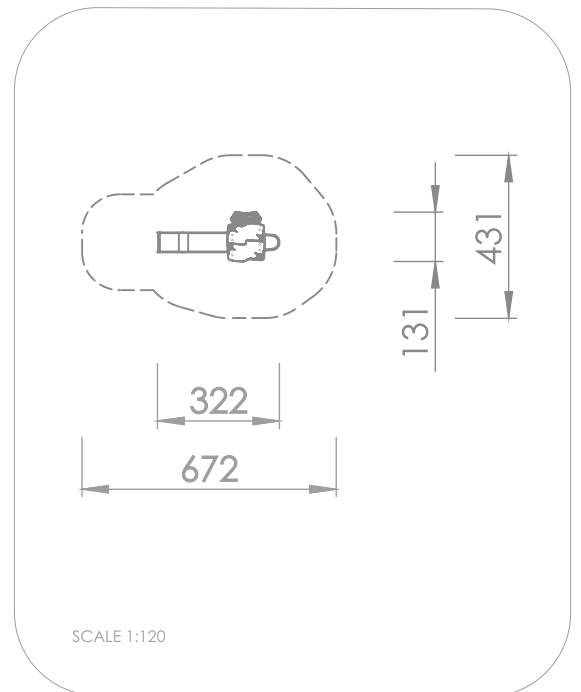
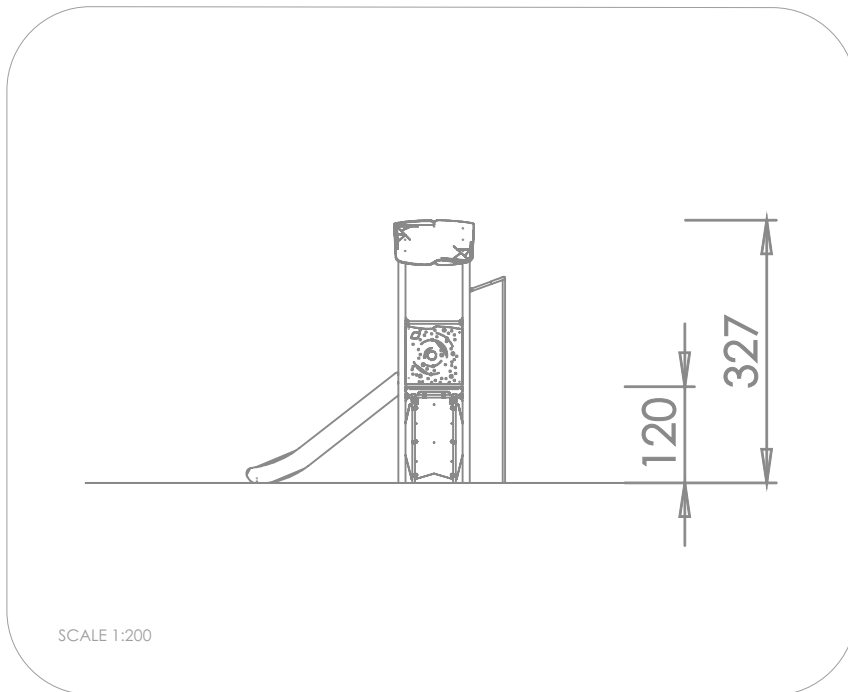
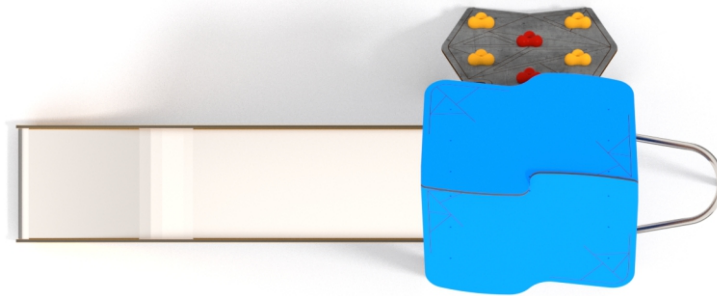

1132

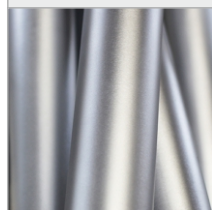

MATERIALS:

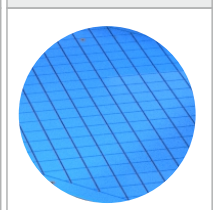
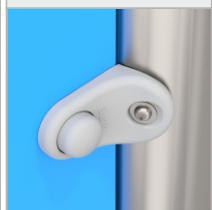
<p>CONSTRUCTION ELEMENTS MADE OF STAINLESS AISI 304</p>	<p>PLATES OF THE WALLS MADE OF COLOURFUL TRIPLE LAYERED 15 MM HDPE POLYETHYLENE, IN THE HIGHEST QUALITY</p>	<p>ANTI-SLIP BLUE 13 MM HPL PLATFORM PLATE SERIES: ACTIV</p>	<p>PLATE AND ROPE CONNECTORS MADE OF INJECTION MOLDED POLYAMIDE</p>	
				
<p>PLATES OF THE WALLS AND PLATFORMS MADE OF COLOURFUL 13 MM HPL IN THE HIGHEST QUALITY</p>	<p>SLIDES MADE OF STAINLESS STEEL AISI 304, SIDE PANELS MADE OF HDPE POLYETHYLENE</p>	<p>CLIMBING ROCKS MADE OF CHIPPINGS AND COLOURFUL POLYESTER RESIN</p>	<p>SYSTEM OF CONNECTORS AND CLAMPS MADE OF STRONG ALUMINUM ALLOY</p>	<p>SOLID CONSTRUCTION MADE BLACK STEEL S235JR CLEANED IN THE SANDBLASTING PROCESS</p>
