



INFORMATION ABOUT THE PRODUCT

Dimensions	17 x 90 cm
Safety zone	317 x 390 cm
Safety zone area	11 m ²
Overall height	125 cm
Free fall height	
Amount of users	1
Product complies with EN 1176-1:2017-12	YES
Availability of spare parts	YES
Age range	1-7

According to EN 1176-1:2017-12 norm, the product requires applying a safety surface according to the product's free fall height.



4136

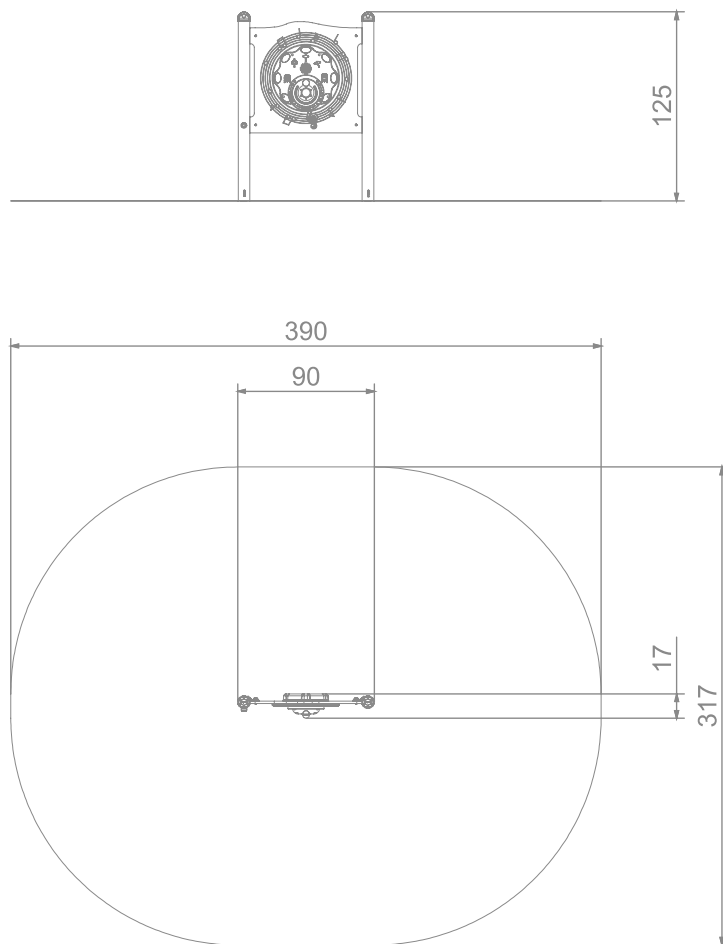

SCALE 1:50

MATERIALS:

SOLID CONSTRUCTION
MADE OF STAINLESS STEEL
AISI 304 TOTALLY RESISTANT
TO WEATHER CONDITIONS

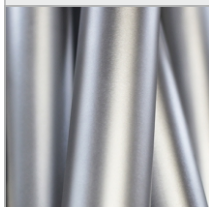

PLATES OF THE WALLS MADE
OF COLORFUL TRIPLE
LAYERED 15 MM HDPE
POLYETHYLENE



SAFE PIPE PLUGS MADE OF
INJECTION MOLDED
POLYAMIDE



PLATE AND ROPE
CONNECTORS MADE OF
INJECTION MOLDED
POLYAMIDE

