

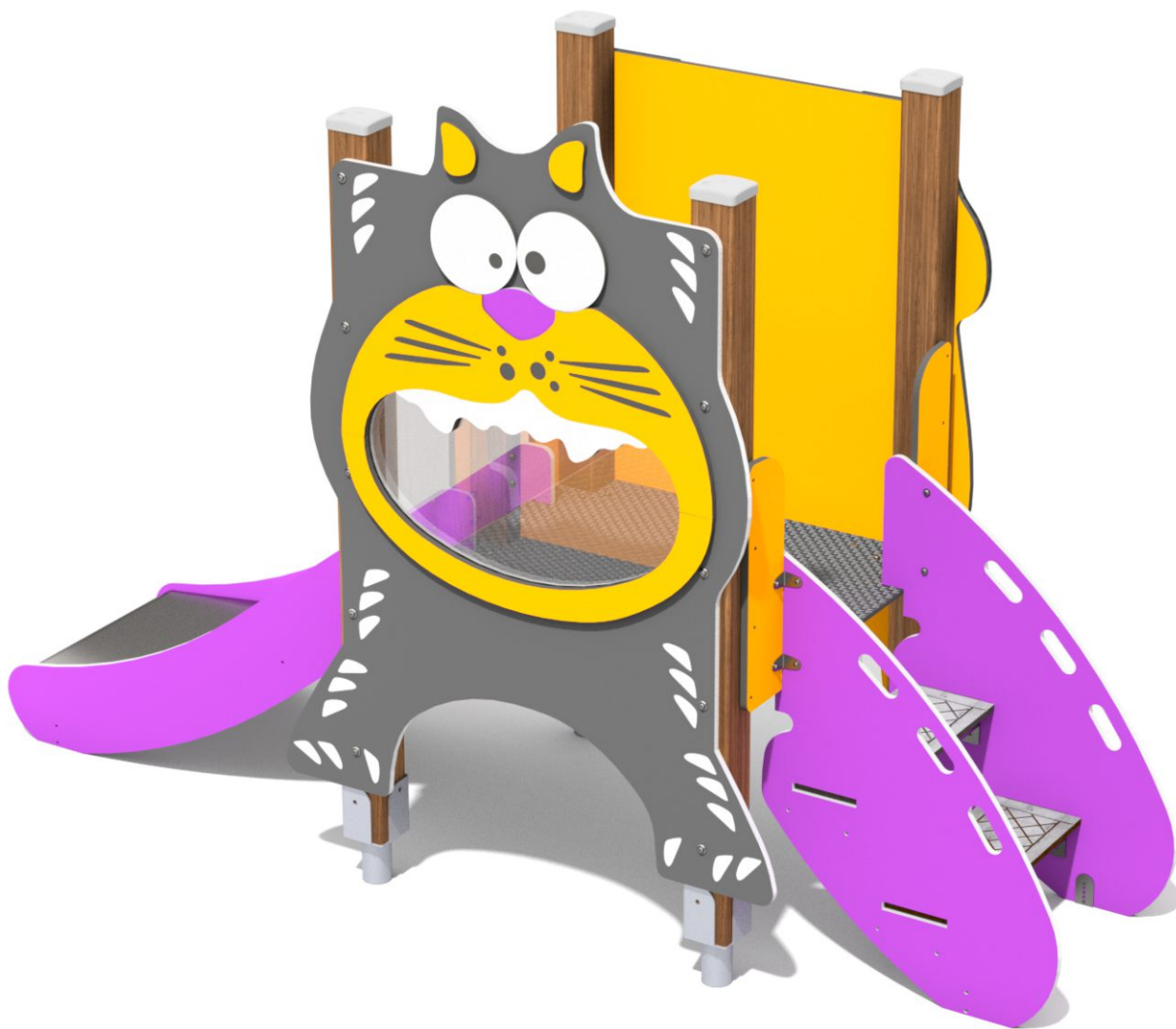

SOCIALIZING



SLIDING



### INFORMATION ABOUT THE PRODUCT

Dimensions	253 x 95 cm
Safety zone	603 x 395 cm
Safety zone area	19 m <sup>2</sup>
Overall height	170 cm
Free fall height	59 cm
Amount of users	4
Product complies with EN 1176-1:2017-12	YES
Availability of spare parts	YES
Age range	1-8
<small>According to EN 1176-1:2017-12 norm, the product requires applying a safety surface according to the product's free fall height.</small>	





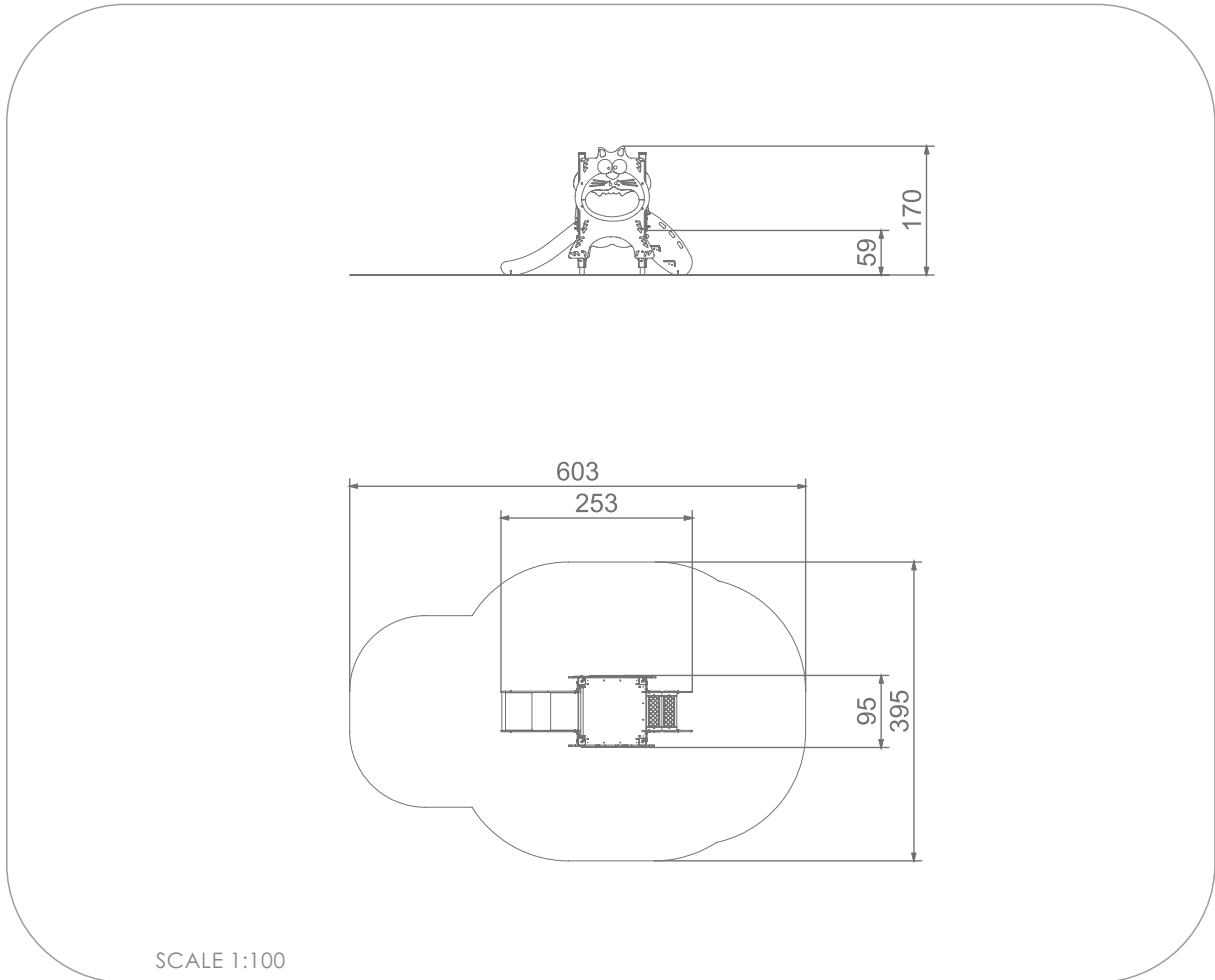



## 8038



SCALE 1:100

### MATERIALS:

<p>SOFT CONIFER WOOD CORELESS, GLUED IN LAYERS WITH POLYURETHANE GLUES, TOTALLY RESISTANT TO WATER.</p>	<p>WOODEN POSTS ANCHORED TO THE GROUND WITH POWDER GALVANIZED AND POWDER COATED STEEL ANCHORS.</p>	<p>PATENTED SYSTEM OF CONNECTORS AND CLAMPS MADE OF STRONG ALUMINIUM ALLOY.</p>
		
<p>ANTI-SLIP ANTHRACITE 10MM HPL PLATFORM PLATE WITH A VERY HIGH RESISTANCE TO WEATHER CONDITIONS AND ATTRITION.</p>	<p>SLIDES MADE OF STAINLESS STEEL AISI 304. METAL SHEET WITH A THICKNESS OF 2 MM FORMED IN A CNC TECHNIQUE.</p>	<p>SYSTEM OF CONNECTORS AND CLAMPS MADE OF STRONG ALUMINIUM ALLOY.</p>
		

PLATES OF THE WALLS MADE OF COLOURFUL TRIPLE LAYERED 15 MM HDPE POLYETHYLENE, IN THE HIGHEST QUALITY, TOTALLY DAMP-PROOF.

