

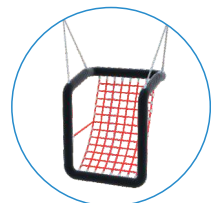

SWINGING



SOCIALIZING



INFORMATION ABOUT THE PRODUCT

Dimensions	ca. 238 x 695 cm
Safety zone	ca. 750 x 650 cm
Overall height	ca. 250 cm
Free fall height	ca. 137 cm
Amount of users	6 persons
Product complies with EN 1176-1:2017-12	YES
Availability of spare parts	YES
Age range	1- 12
<small>According to EN 1176-1:2017-12 norm, the product requires applying a safety surface according to the product's free fall height.</small>	

Visualisation is for reference only,
actual appearance may vary.



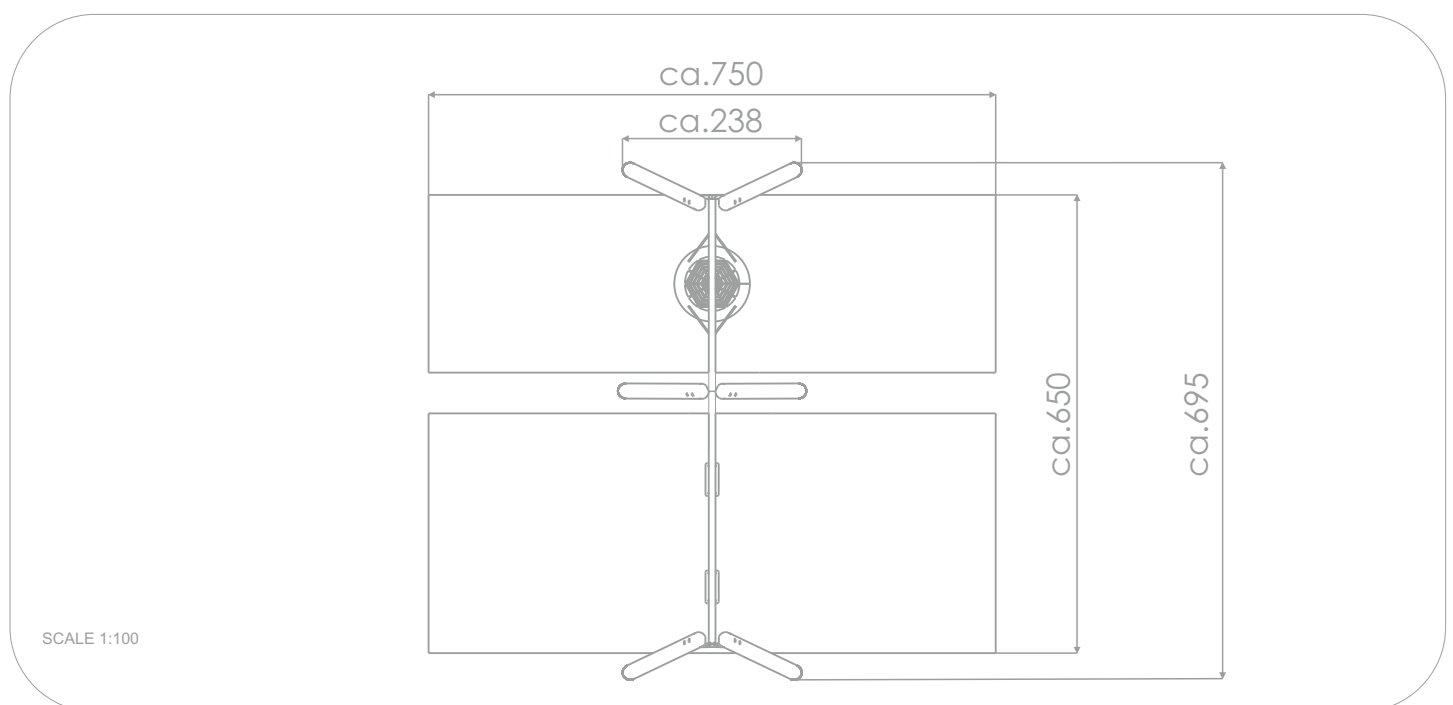
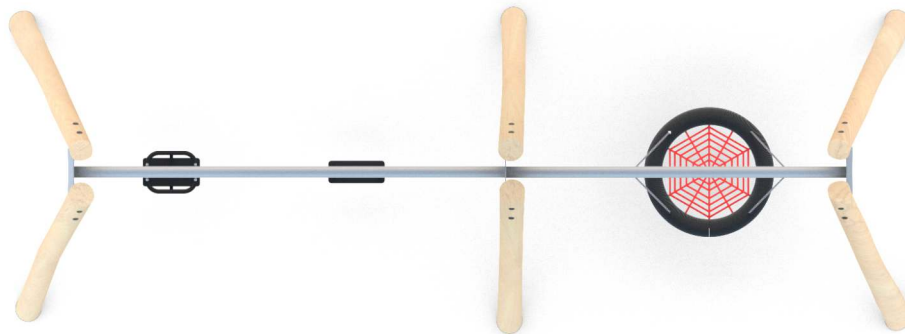

MATERIALS:

„BIRD NEST“ TYPE SEAT WITH A DIAMETER OF 100 CM, HANGED ON 6 MM STAINLESS STEEL CHAINS



SAFETY SEAT MADE OF ALUMINIUM AND STAINLESS STEEL COVERED WITH SOFT POLYURETHANE

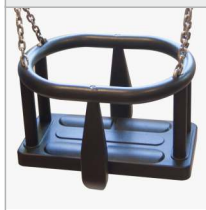

THE SEATS ARE MADE WITH AN ALUMINIUM CONSTRUCTION COVERED WITH A SOFT EPDM RUBBER

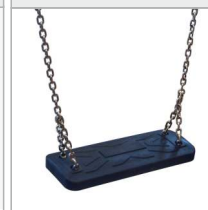

NATURAL ROBINIA WOOD



ATTESTED 6 MM STAINLESS STEEL CHAINS



SOLID CONSTRUCTION MADE OF BLACKSTEEL S235JR, CLEANED IN THE SANDBLASTING PROCESS

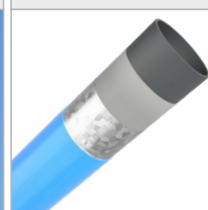

SWINGS, SLINGS WITH DOUBLE BEARINGS MADE OF STAINLESS STEEL

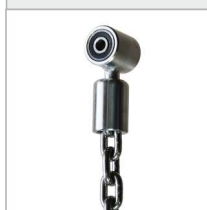

OPTIONAL:

BACK SUPPORT OF THE SEAT WITH STEEL CONSTRUCTION COVERED WITH SOFT POLYURETHANE



SEAT WITH A CONSTRUCTION MADE OF ALUMINIUM AND STAINLESS STEEL, DEDICATED FOR MOTHER AND CHILD

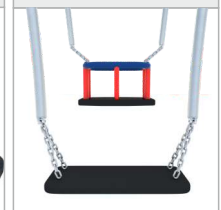

APPROVED SEAT – SEAT TYPE – HANGED ON R 6 MM CHAINS MADE OF STAINLESS STEEL METAL FRAME COVERED BY SOFT POLYPROPYLENE ROPE



APPROVED SEAT MADE WITH ROTOMOULDED METHOD, DEDICATED FOR DISABLED USERS

